

# Generic model of oligarchy

Understanding the real social  
architecture

# Understanding the real social architecture

In order to change the course of human history so that we can have a true egalitarian society where the benefits of the social order are provided to all members of the population, we must recognize the true nature of the existing societies and base any solutions on that reality.

Otherwise we just change the label on the same old system.

Basic model describing the architecture of the oligarchic system.

The architecture of the oligarchic system.

- 1) Oligarchs
- 2) those who support the oligarchs, get paid off for their support ,  
and who depend on the system for their livelihood.
- 3) those who are held captive by the oligarchic system.

## Basic model describing the architecture of the oligarchic system.

In an tyrannical system such as a kingdom or empire, the categories are:

Oligarchs	King, aristocrats, wealthy and powerful	Subset of the Upper Class
Wealthy and powerful	Those who control the majority of the wealth and resources.	Upper Class
Supporters	Those whose livelihoods are based on providing goods and services for the oligarchs. e.g Merchants, religious figures, military.	Middle Class
Captives/ Slaves	Population who produces low-skilled goods and services.	Lower Class

## Basic model describing the architecture of the oligarchic system.

In an "democratic" system such as a republic the categories are:

Oligarchs	Heads of corporations, heads of governmental institutions, wealthy and powerful	Subset of the Upper Class
Wealthy and powerful	Those who control the majority of the wealth and resources.	Upper Class
Supporters	Those whose livelihoods are based on providing goods and services to the oligarchs. e.g Merchants( corporations) , administrators of social institutions such as education, military, police, religion, etc.	Middle Class
"the poor"	Population who produces low skilled goods and services.	Lower Class

# Characteristics of people in the 4 classes of an oligarchy

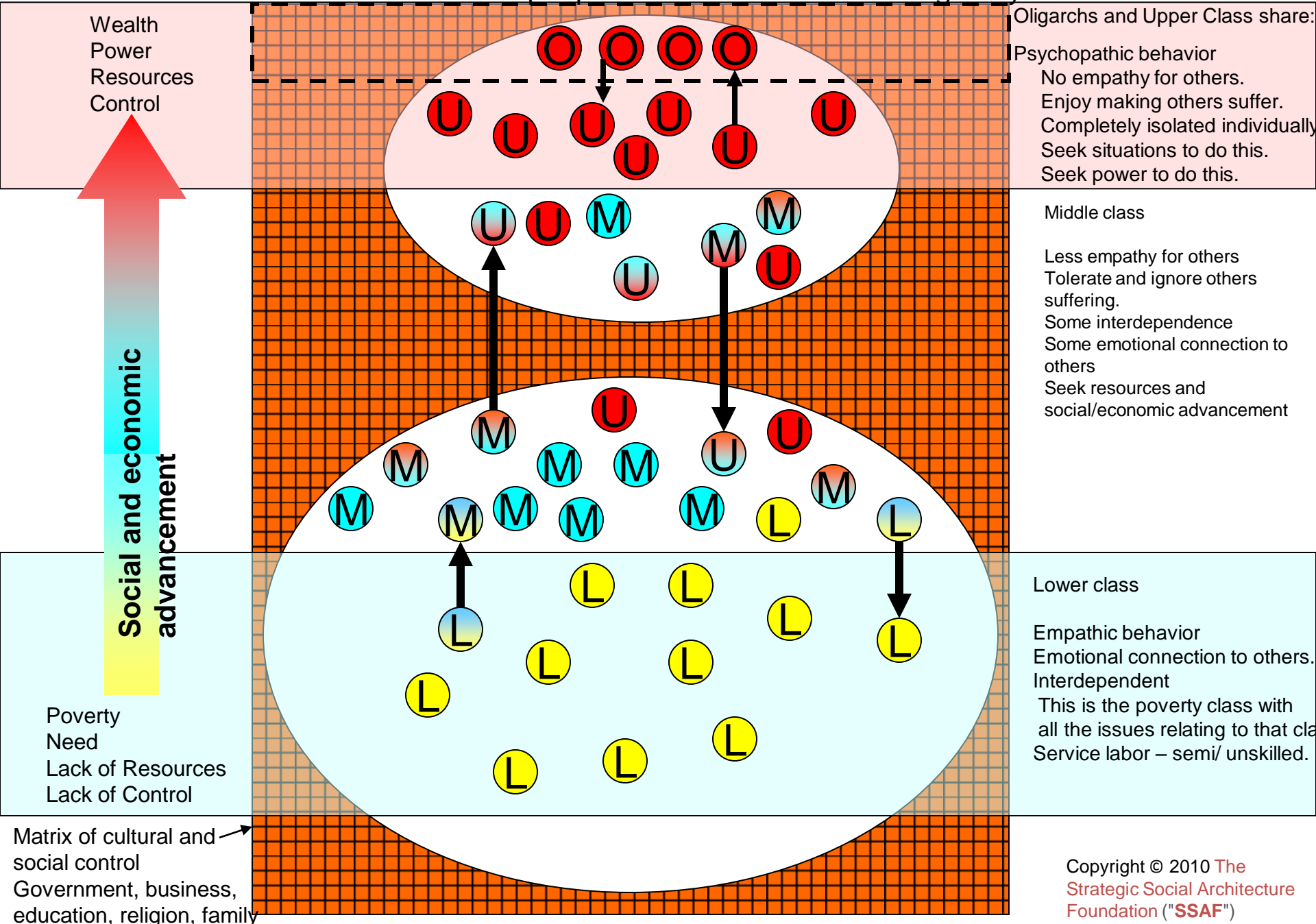

Poverty  
Need  
Lack of Resources  
Lack of Control

**Social and economic advancement**

Matrix of cultural and social control  
Government, business, education, religion, family

# Generic model of oligarchy

Levels of abstraction insulate oligarchs from observation by and repercussions from the general population

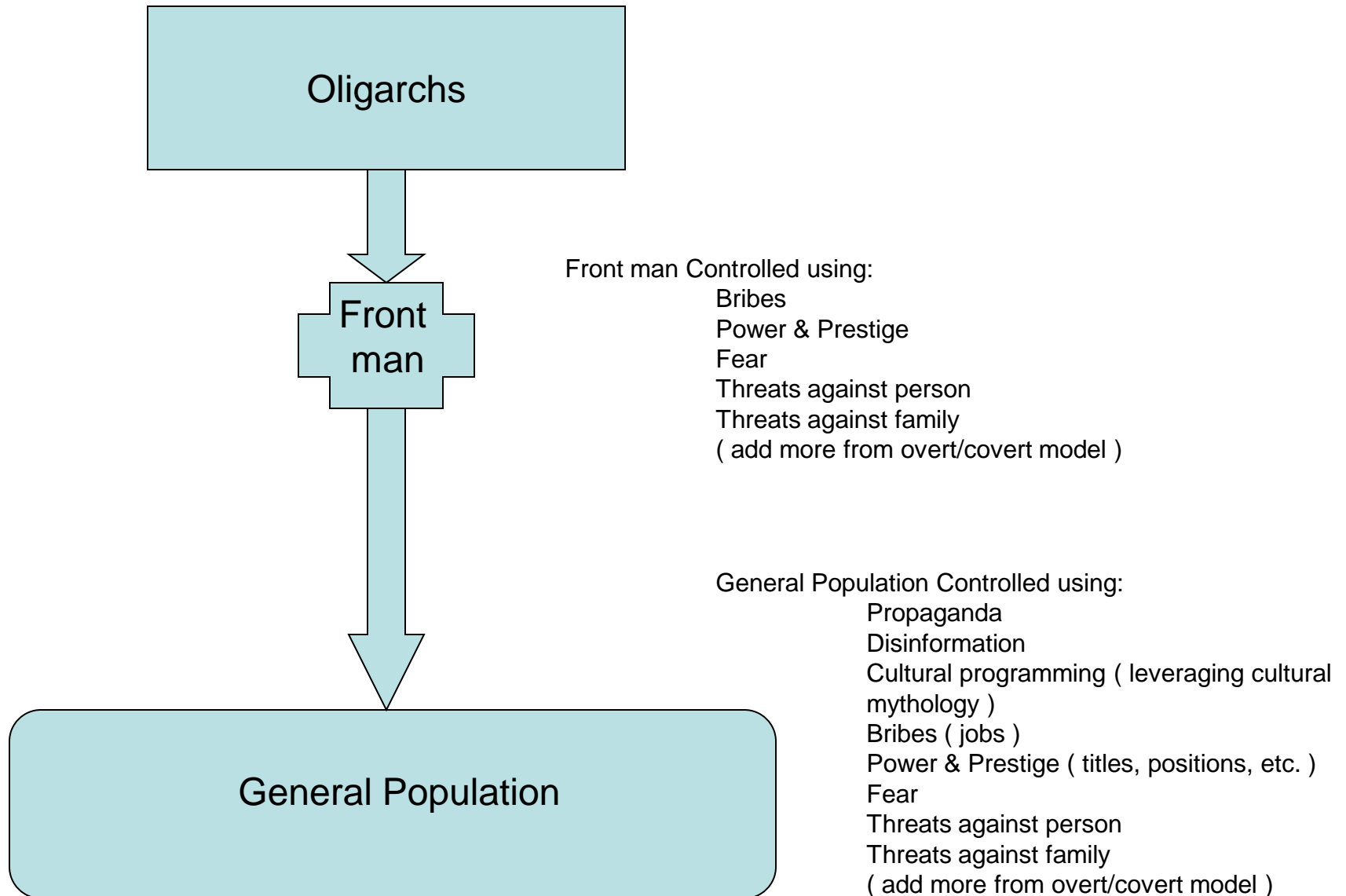

Groups of front people work together in institutions



# Groups of front people work together in institutions

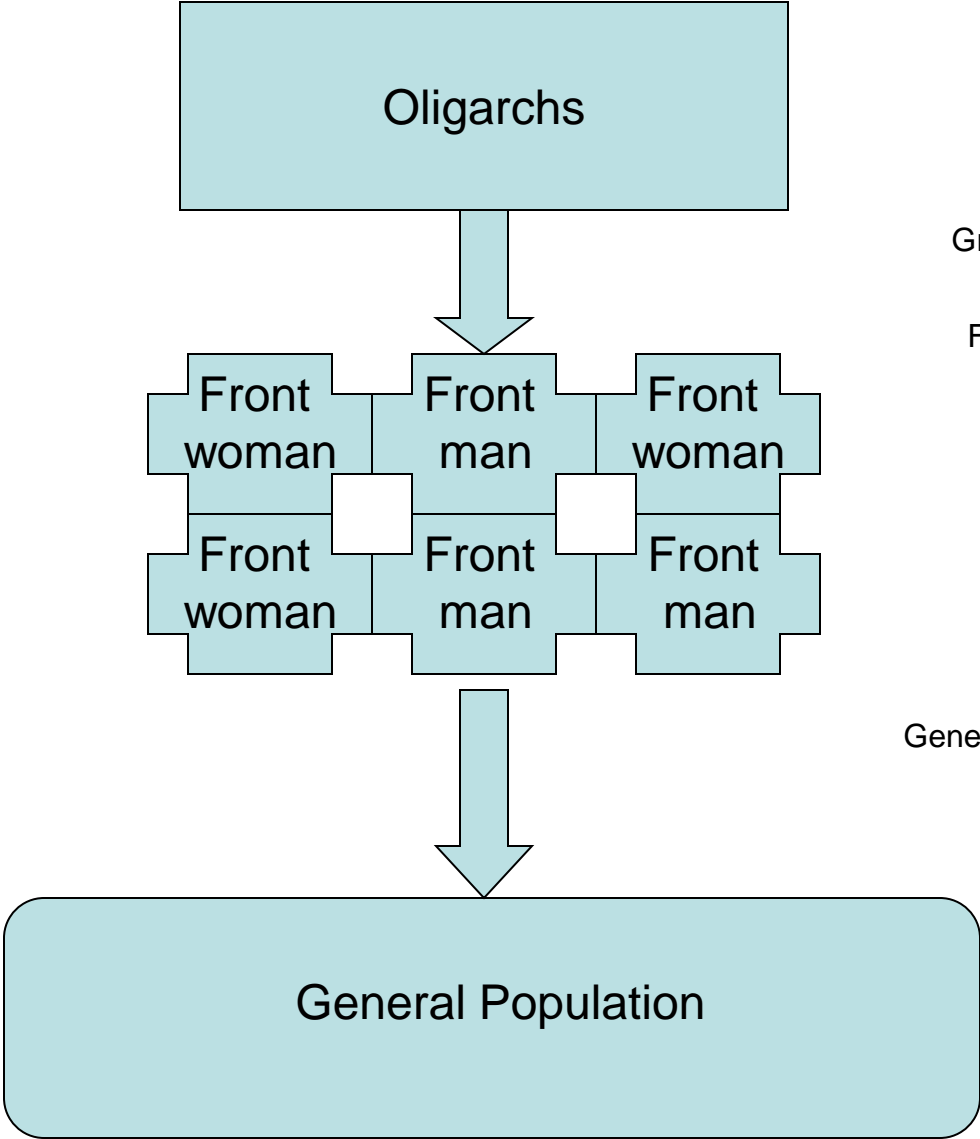

Groups of front people work together in institutions

- Front group Controlled using:
- Bribes
  - Power & Prestige
  - Fear
  - Threats against person
  - Threats against family
  - ( add more from overt/covert model )

- General Population Controlled using:
- Propaganda
  - Disinformation
  - Cultural programming ( leveraging cultural mythology )
  - Bribes ( jobs )
  - Power & Prestige ( titles, positions, etc. )
  - Fear
  - Threats against person
  - Threats against family
  - ( add more from overt/covert model )

Some front people understand their role.  
Most are simply “doing their job”.

# Some front people understand their role. Most are simply “doing their job”.

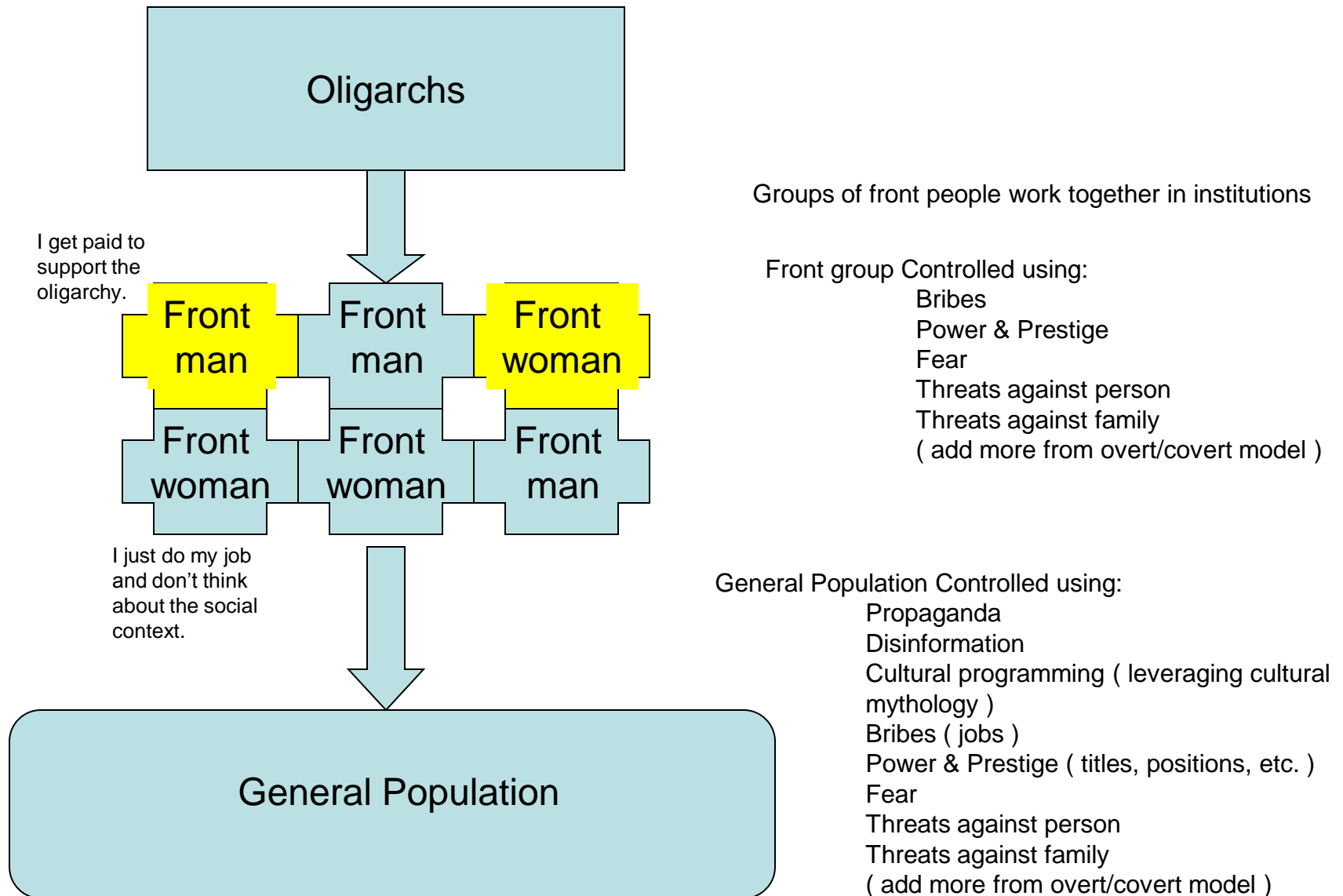

# Religious institution

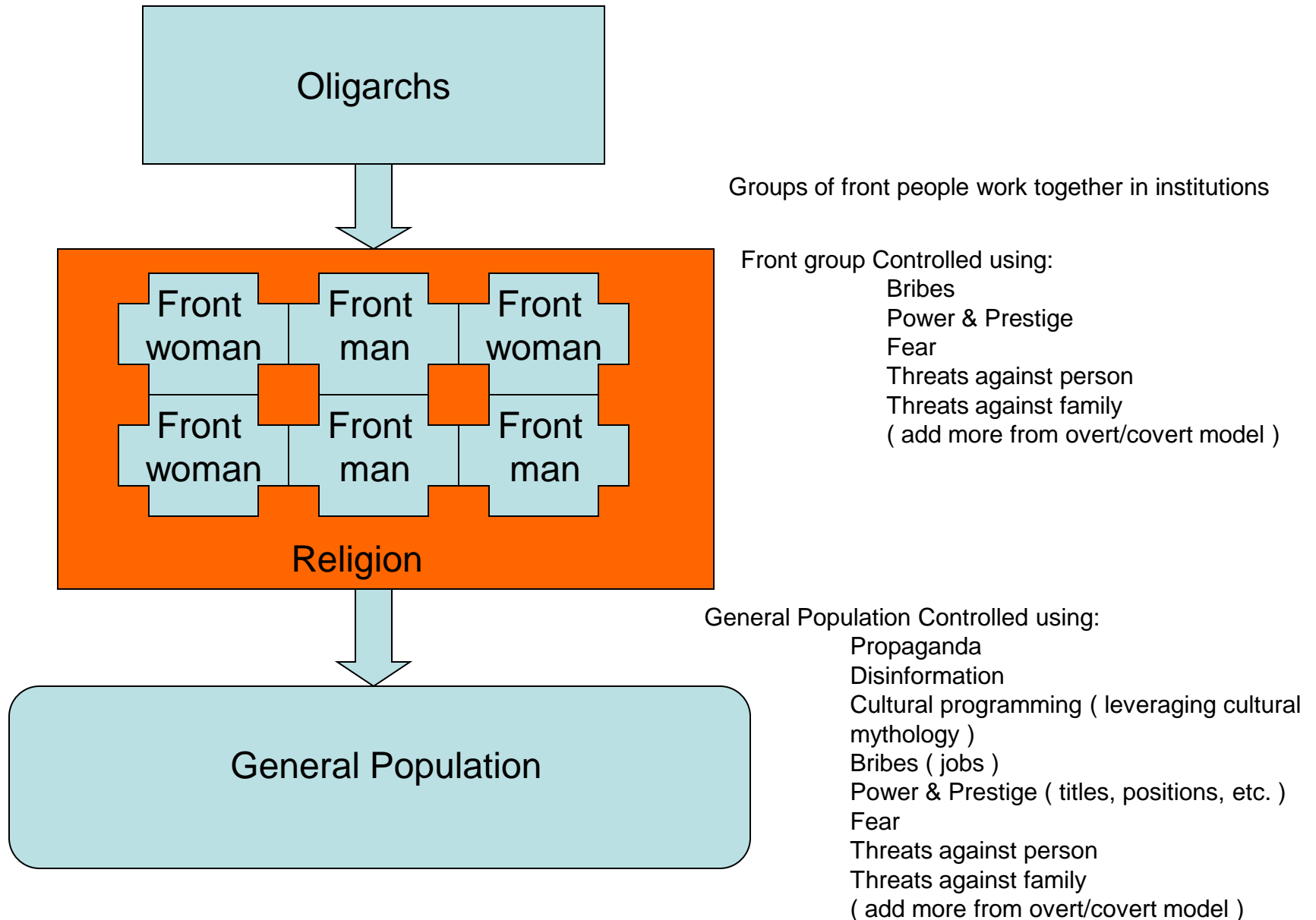

# Government institution

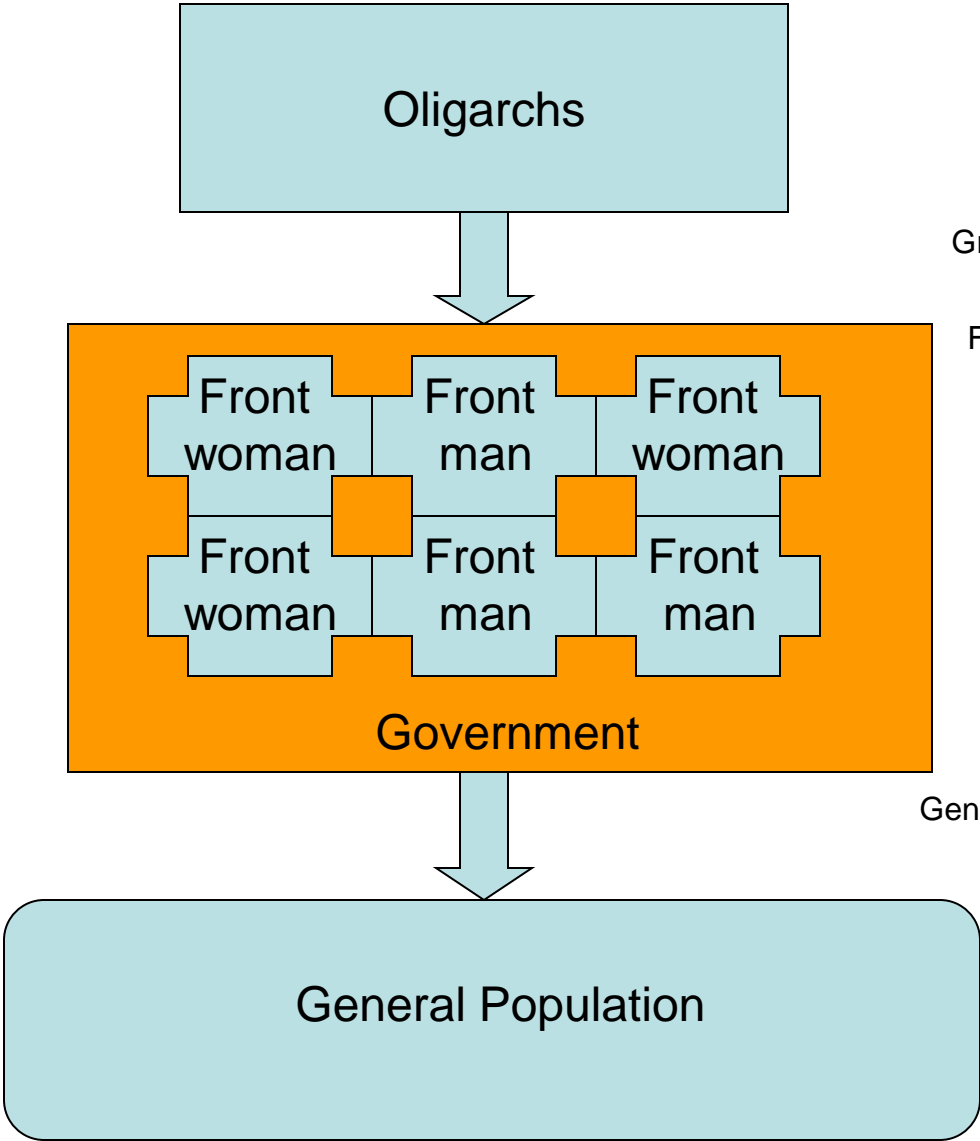

Groups of front people work together in institutions

Front group Controlled using:  
Bribes  
Power & Prestige  
Fear  
Threats against person  
Threats against family  
( add more from overt/covert model )

General Population Controlled using:  
Propaganda  
Disinformation  
Cultural programming ( leveraging cultural mythology )  
Bribes ( jobs )  
Power & Prestige ( titles, positions, etc. )  
Fear  
Threats against person  
Threats against family  
( add more from overt/covert model )

# Educational institution

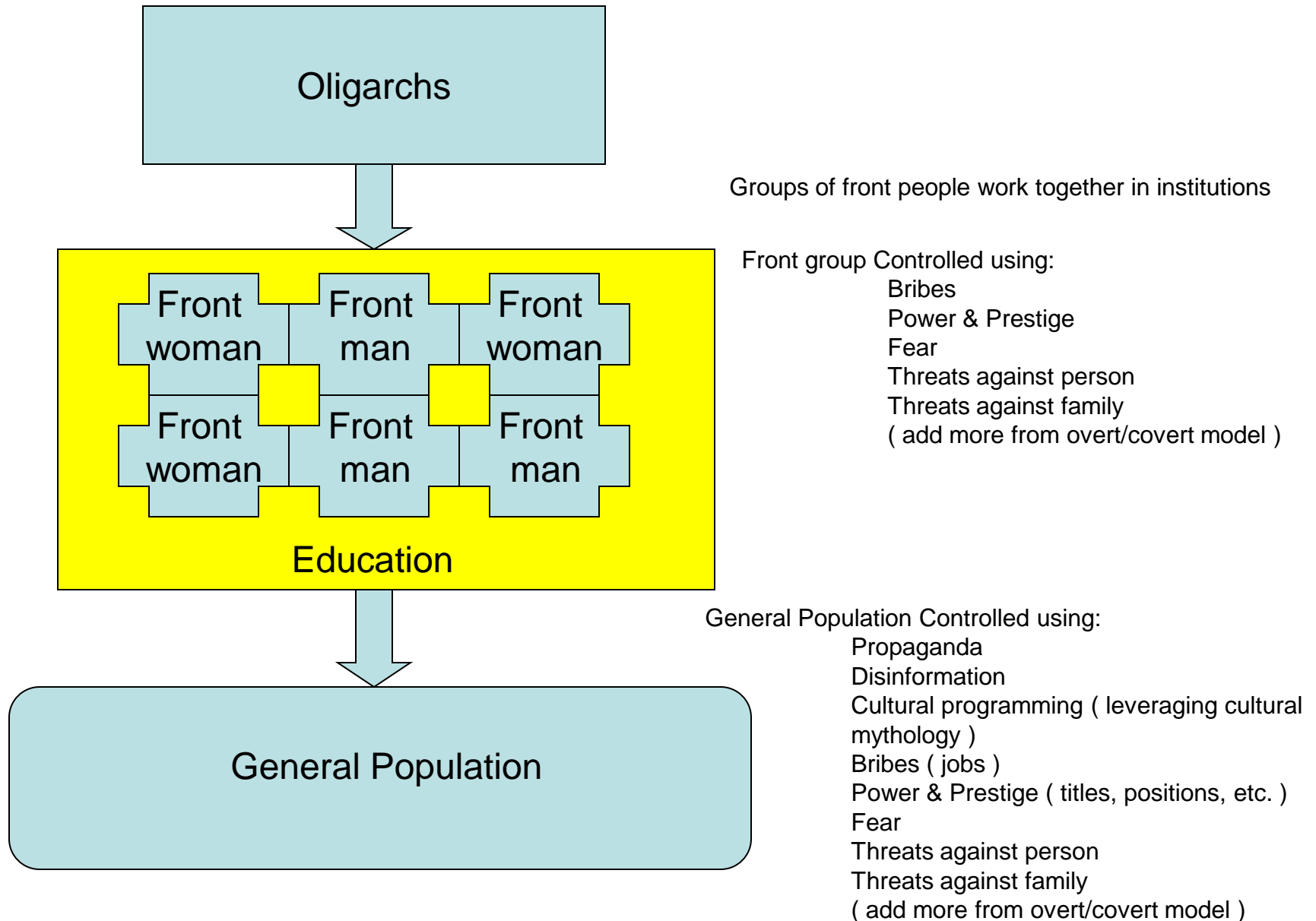

# Corporate institution

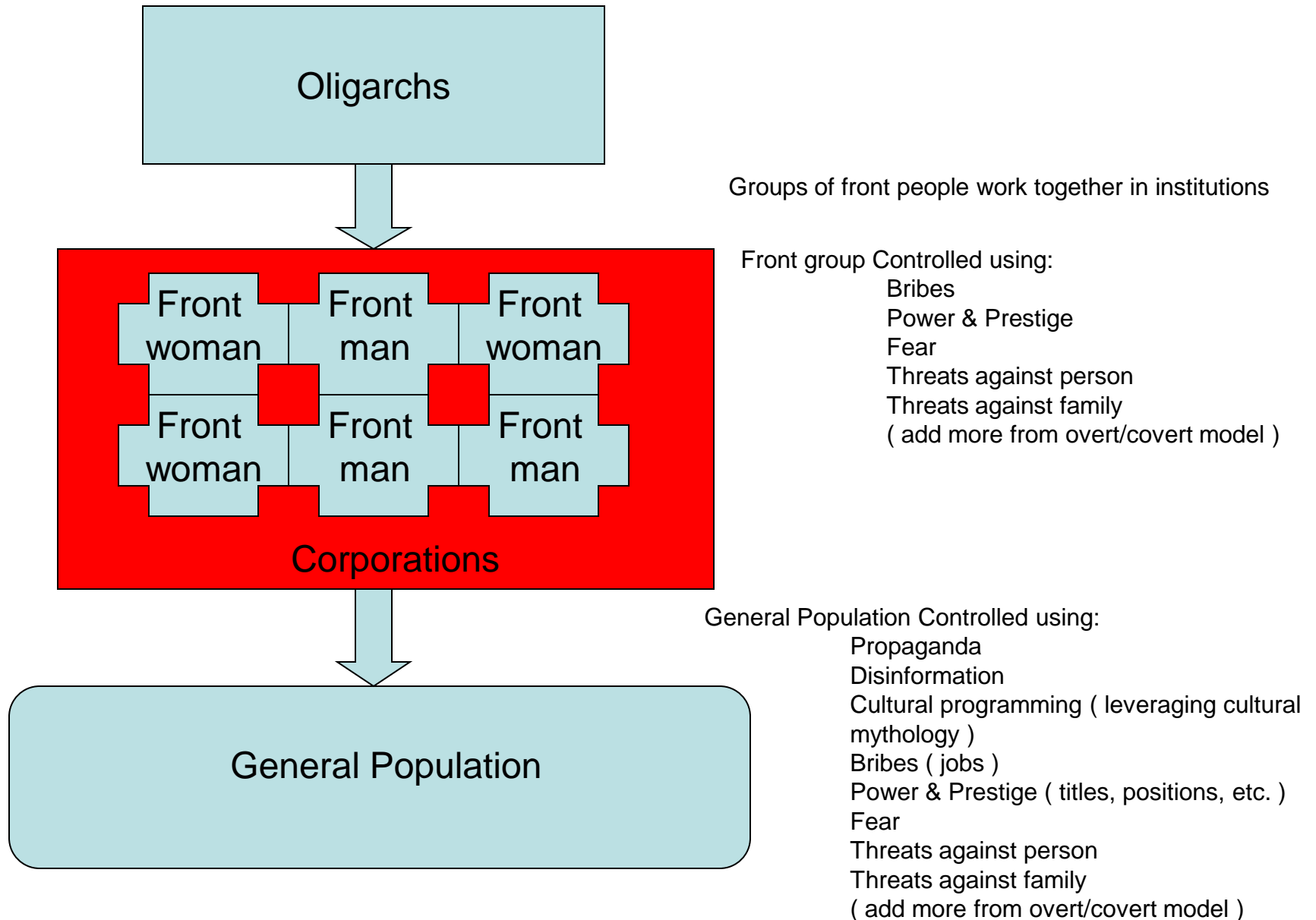

# Police & Military Institutions

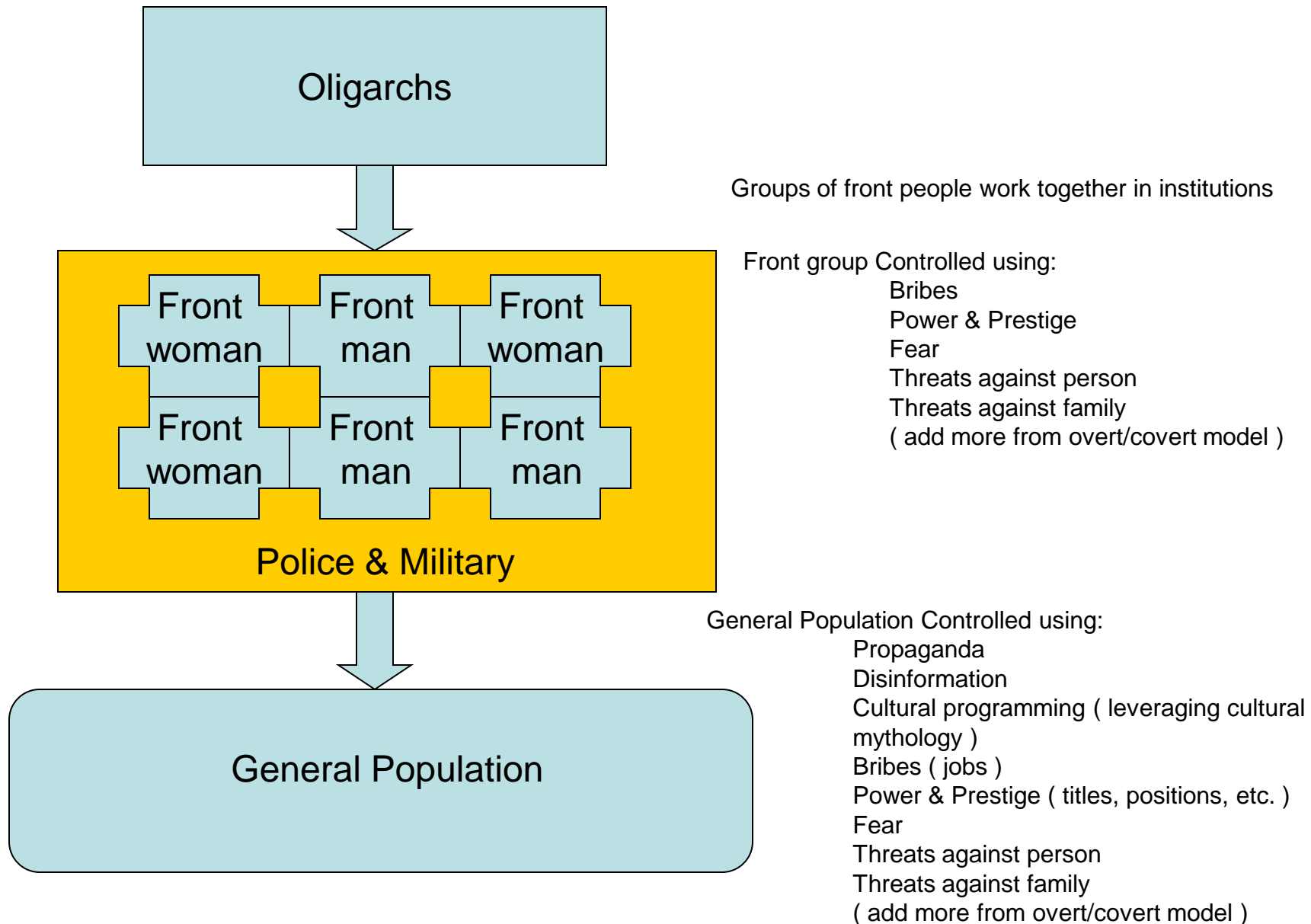



# Media Institutions

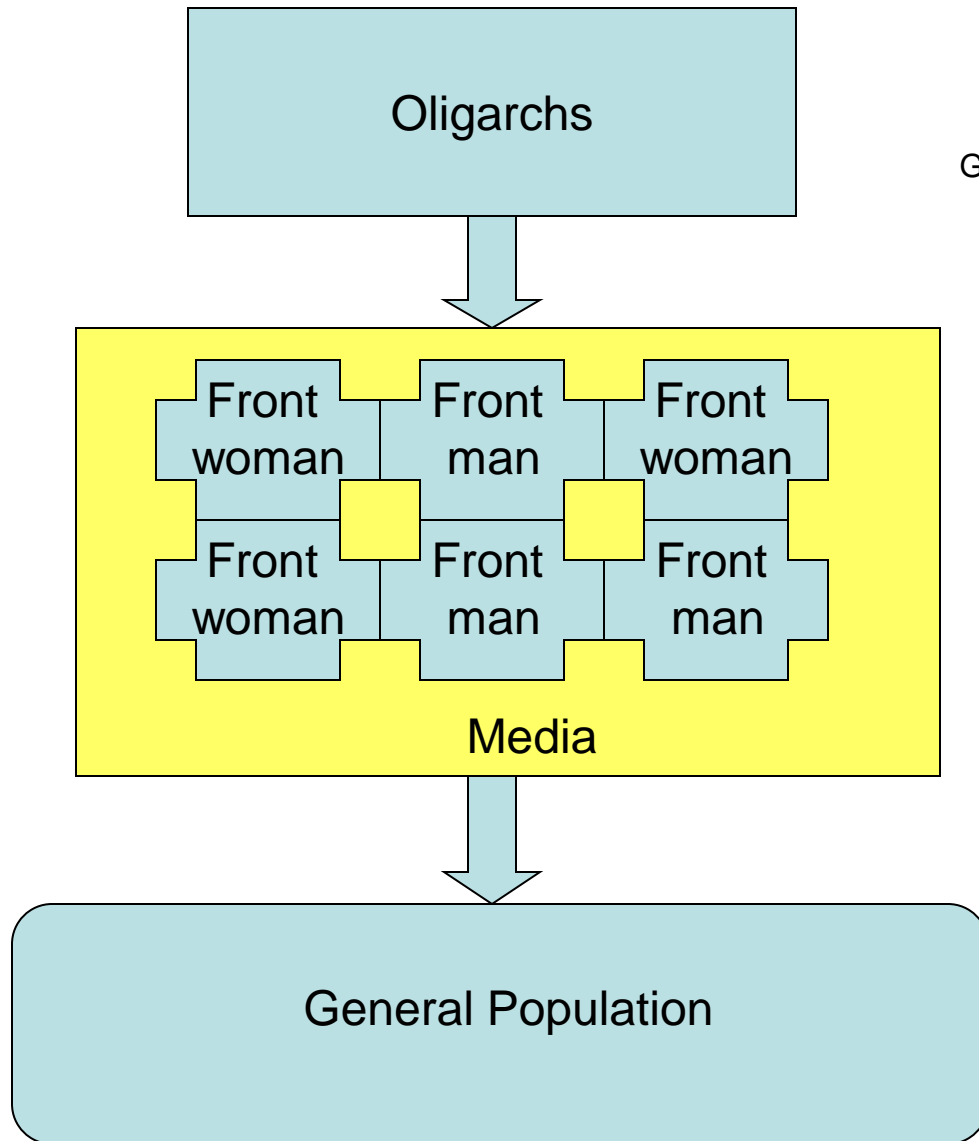

Groups of front people work together in institutions

Front Group Controlled using:

- Propaganda
- Disinformation
- Cultural programming ( leveraging cultural mythology )
- Bribes ( jobs )
- Power & Prestige ( titles, positions, etc. )
- Fear
- Threats against person
- Threats against family  
( add more from overt/covert model )
- Peer pressure

General Population Controlled using:

- Propaganda
- Disinformation
- Cultural programming ( leveraging cultural mythology )
- Bribes ( jobs )
- Power & Prestige ( titles, positions, etc. )
- Fear
- Threats against person
- Threats against family  
( add more from overt/covert model )

# Collection of control institutions form a matrix of social control systems

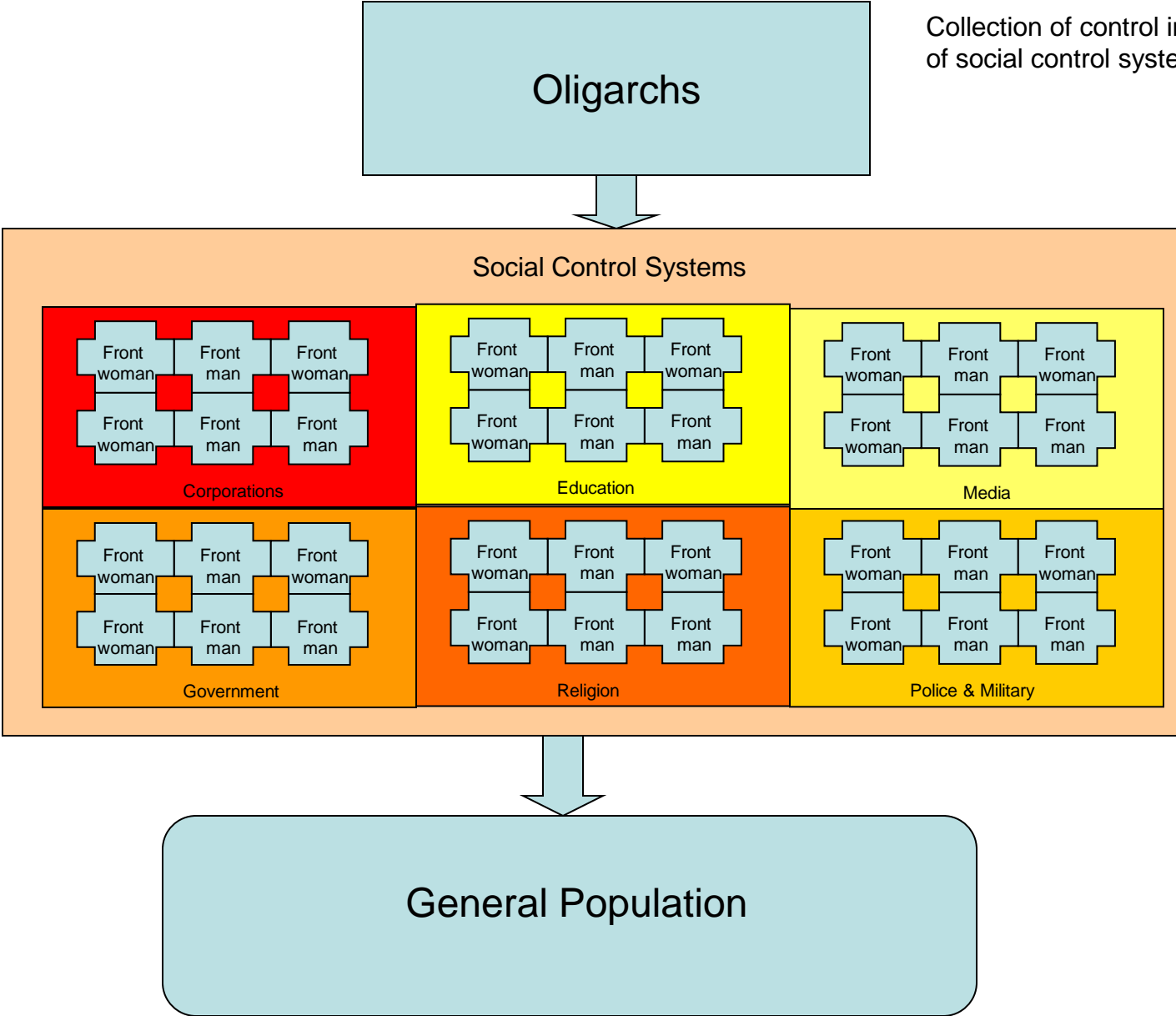

Collection of control institutions form the matrix of social control systems

- Front Groups Controlled using:
- Propaganda
  - Disinformation
  - Cultural programming ( leveraging cultural mythology )
  - Bribes ( jobs )
  - Power & Prestige ( titles, positions, etc. )
  - Fear
  - Threats against person
  - Threats against family ( add more from overt/covert model )
  - Peer pressure

- General Population Controlled using:
- Propaganda
  - Disinformation
  - Cultural programming ( leveraging cultural mythology )
  - Bribes ( jobs )
  - Power & Prestige ( titles, positions, etc. )
  - Fear
  - Threats against person
  - Threats against family ( add more from overt/covert model )
  - Peer pressure

# The social control system encompass the general population to create a complete matrix of social control

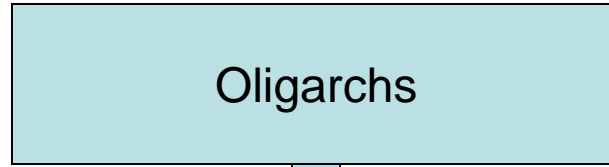

Collection of control institutions form the matrix of social control systems

## MATRIX of Social Control

### Social Control Systems

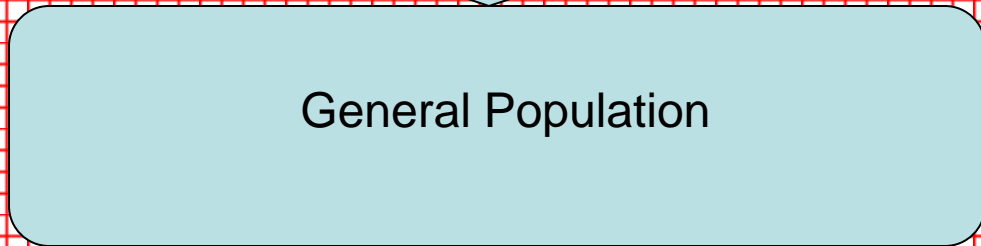
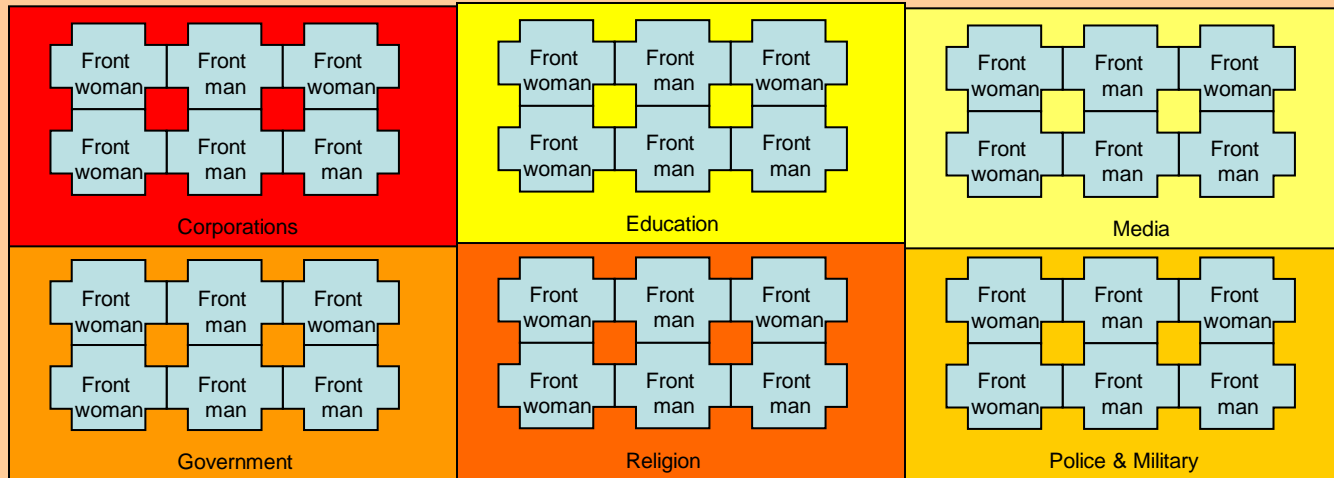

Front Groups Controlled using:

- Propaganda
- Disinformation
- Cultural programming ( leveraging cultural mythology )
- Bribes ( jobs )
- Power & Prestige ( titles, positions, etc. )
- Fear
- Threats against person
- Threats against family ( add more from overt/covert model )
- Peer pressure

General Population Controlled using:

- Propaganda
- Disinformation
- Cultural programming ( leveraging cultural mythology )
- Bribes ( jobs )
- Power & Prestige ( titles, positions, etc. )
- Fear
- Threats against person
- Threats against family ( add more from overt/covert model )
- Peer pressure

Actual reality of the system is complex which is why it is difficult for the general population to see and understand it.

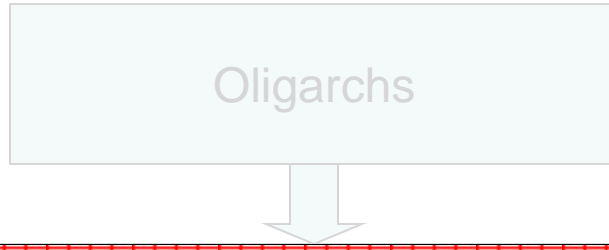

Collection of control institutions form the matrix of social control systems

## MATRIX of Social Control

### Social Control Systems

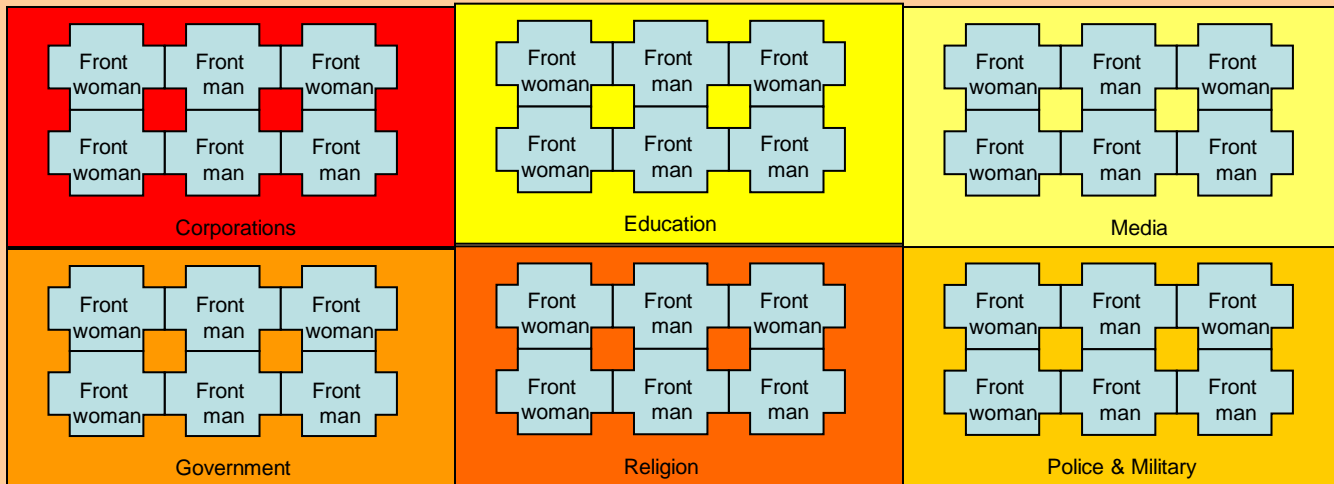

Front Groups Controlled using:

- Propaganda
- Disinformation
- Cultural programming ( leveraging cultural mythology )
- Bribes ( jobs )
- Power & Prestige ( titles, positions, etc. )
- Fear
- Threats against person
- Threats against family ( add more from overt/covert model )
- Peer pressure

General Population Controlled using:

- Propaganda
- Disinformation
- Cultural programming ( leveraging cultural mythology )
- Bribes ( jobs )
- Power & Prestige ( titles, positions, etc. )
- Fear
- Threats against person
- Threats against family ( add more from overt/covert model )
- Peer pressure

## General Population

How does the system work? No one taught me how to see this. They taught me it was democracy. It is too complicated for me to understand so I give up trying.



I leave the responsibility for control of the system up to the "experts" and "leaders" of the social control institutions. They tell me what is right.

# General population cannot see the oligarchs in modern social systems

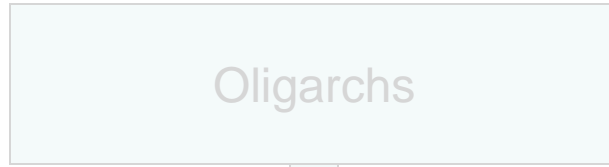

Collection of control institutions form the matrix of social control systems

## MATRIX of Social Control

### Social Control Systems

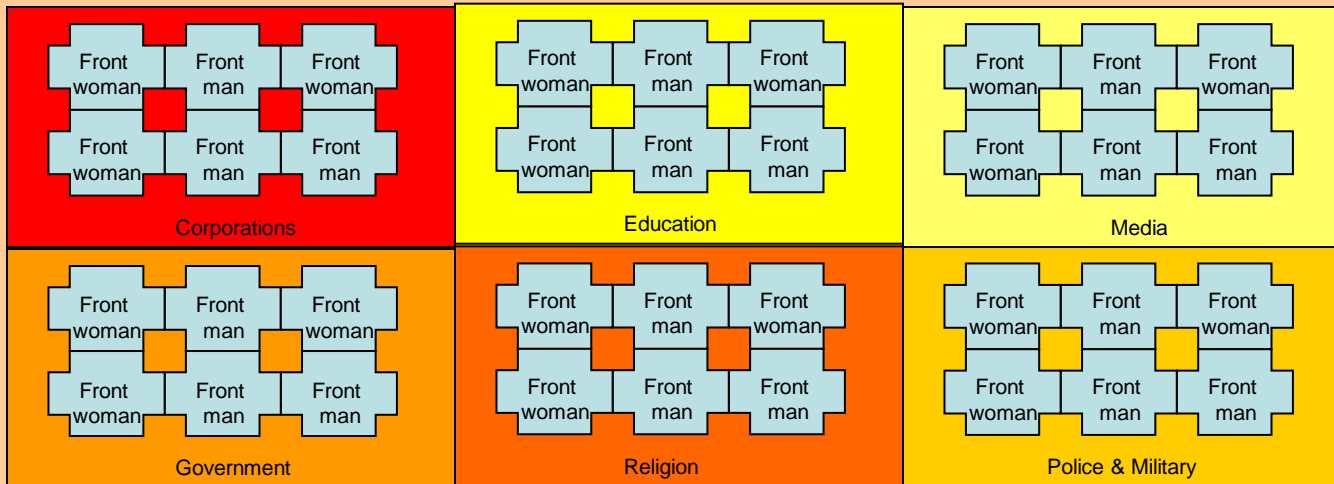

Front Groups Controlled using:

- Propaganda
- Disinformation
- Cultural programming ( leveraging cultural mythology )
- Bribes ( jobs )
- Power & Prestige ( titles, positions, etc. )
- Fear
- Threats against person
- Threats against family ( add more from overt/covert model )
- Peer pressure

General Population Controlled using:

- Propaganda
- Disinformation
- Cultural programming ( leveraging cultural mythology )
- Bribes ( jobs )
- Power & Prestige ( titles, positions, etc. )
- Fear
- Threats against person
- Threats against family ( add more from overt/covert model )
- Peer pressure

## General Population

I don't see any Oligarchs.  
All I see are the institutions.  
No one is controlling the system!  
I have Liberty and Freedom!



General population is deceived into thinking that the social control institutions will alert them to the existence of oligarchs and exert control over the oligarchs.

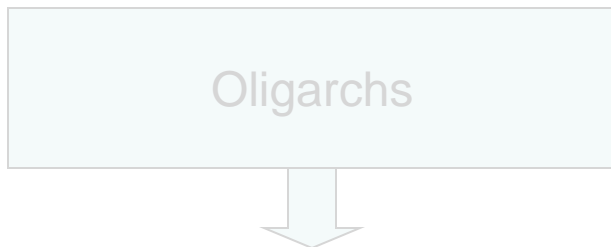

Collection of control institutions form the matrix of social control systems

## MATRIX of Social Control

### Social Control Systems

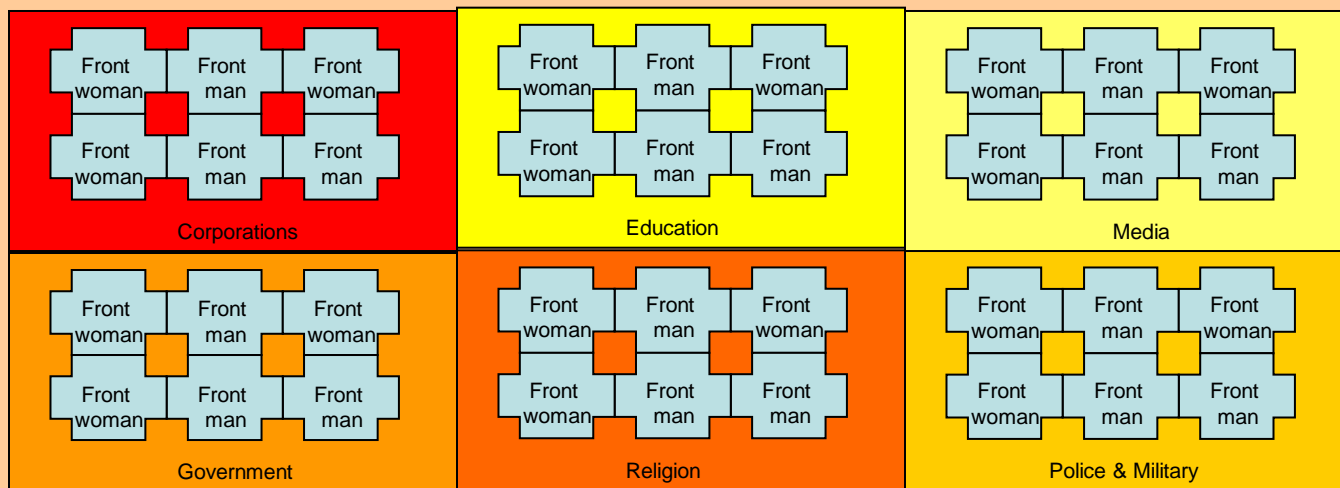

Front Groups Controlled using:

- Propaganda
- Disinformation
- Cultural programming ( leveraging cultural mythology )
- Bribes ( jobs )
- Power & Prestige ( titles, positions, etc. )
- Fear
- Threats against person
- Threats against family ( add more from overt/covert model )
- Peer pressure

General Population Controlled using:

- Propaganda
- Disinformation
- Cultural programming ( leveraging cultural mythology )
- Bribes ( jobs )
- Power & Prestige ( titles, positions, etc. )
- Fear
- Threats against person
- Threats against family ( add more from overt/covert model )
- Peer pressure

## General Population

If there were oligarchs the media would tell me, the police would arrest them and the government would protect me!



In addition, actual reality of social control matrix is intentionally hidden behind cultural mythology

In addition, actual reality of social control matrix is intentionally hidden behind cultural mythology

Oligarchs

Collection of control institutions form the matrix of social control systems



General Population

America ll the way! Yeah!





This model is the same for EVERY society

This model is the same for EVERY society

Oligarchs

Collection of control institutions form the matrix of social control systems

<insert picture of any nation here>

<insert nation name here> is the best!

General Population

My Nation all the way!  
Yeah!



In reality, nations are nothing but areas of control for a certain group of oligarchs.

Country A

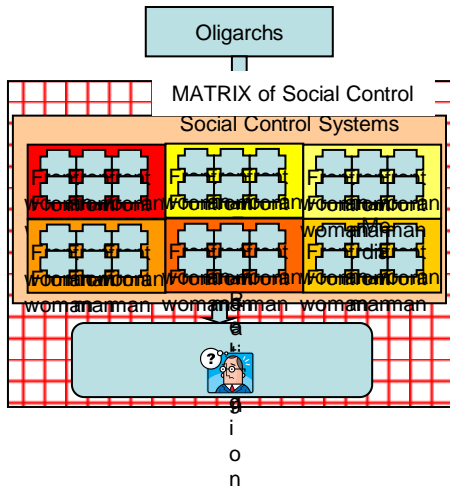

Country C

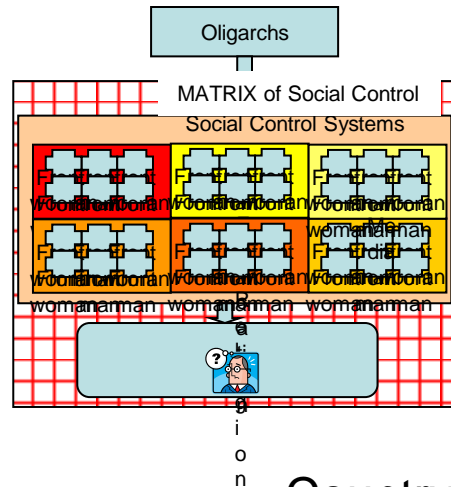

Country E

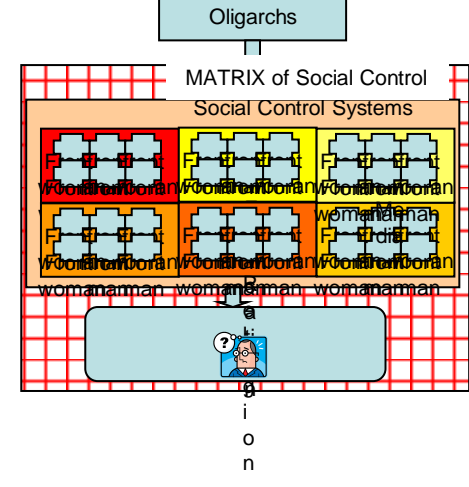

Country B

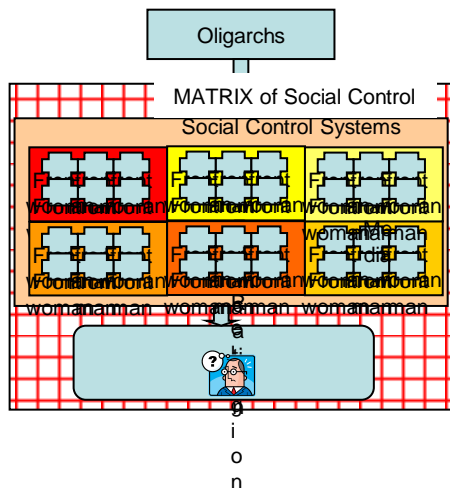

Country D

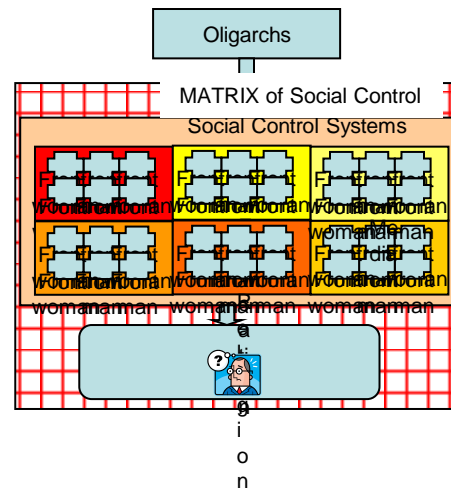

In reality, nations are nothing but areas of control for a certain group of oligarchs. It's all the same model.

### United States

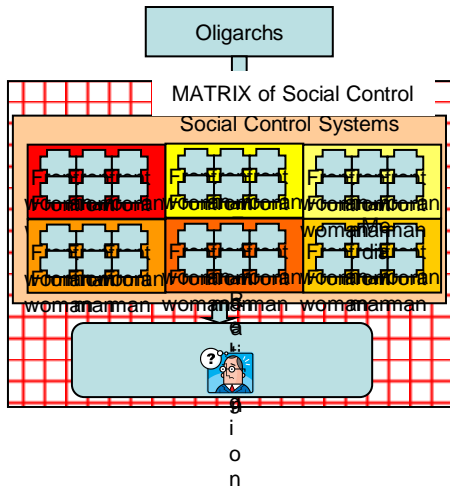

### United Kingdom

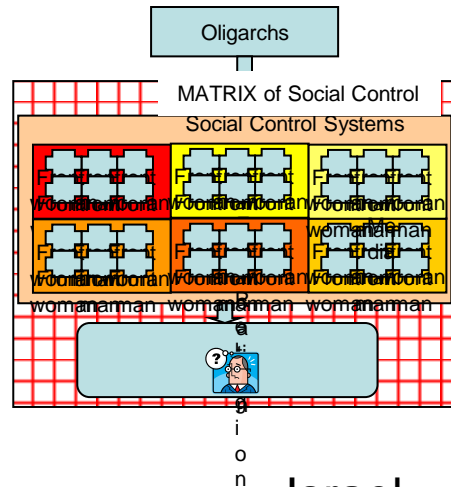

### China

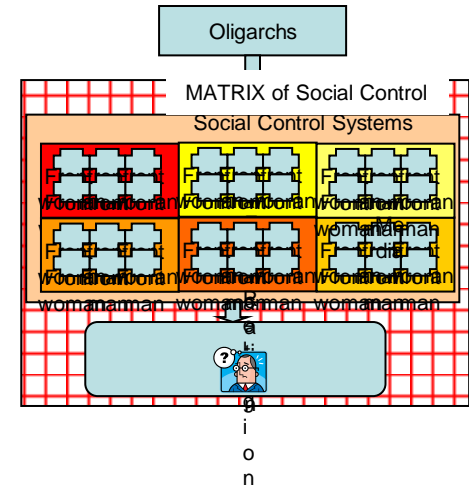

### Russia

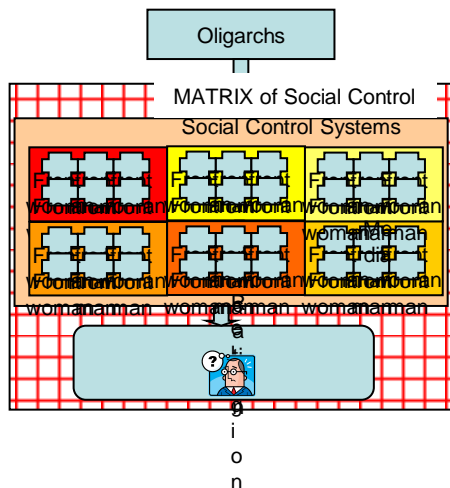

### Israel

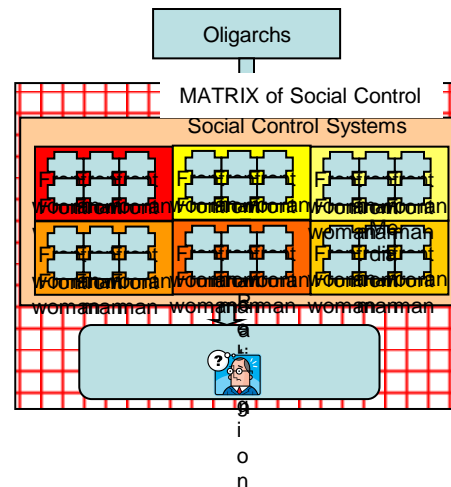

Etc, etc, etc,...

Which religion doesn't matter. It doesn't change the model at all.

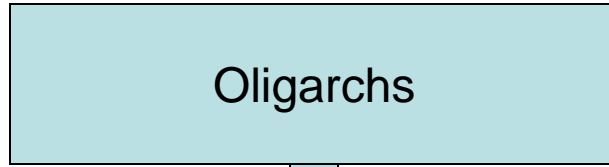

Collection of control institutions form the matrix of social control systems

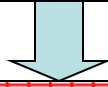

## MATRIX of Social Control

### Social Control Systems

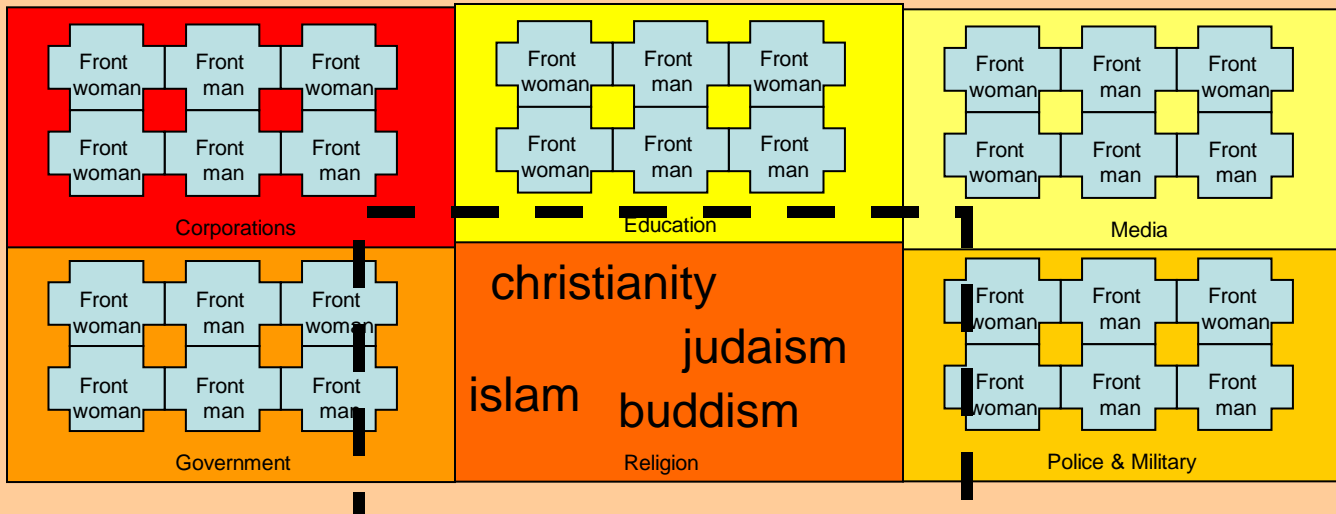

Front Groups Controlled using:

- Propaganda
- Disinformation
- Cultural programming ( leveraging cultural mythology )
- Bribes ( jobs )
- Power & Prestige ( titles, positions, etc. )
- Fear
- Threats against person
- Threats against family ( add more from overt/covert model )
- Peer pressure

General Population Controlled using:

- Propaganda
- Disinformation
- Cultural programming ( leveraging cultural mythology )
- Bribes ( jobs )
- Power & Prestige ( titles, positions, etc. )
- Fear
- Threats against person
- Threats against family ( add more from overt/covert model )
- Peer pressure

General Population

Which government system doesn't matter. It doesn't change the model at all.

Oligarchs

Collection of control institutions form the matrix of social control systems

MATRIX of Social Control

Social Control Systems

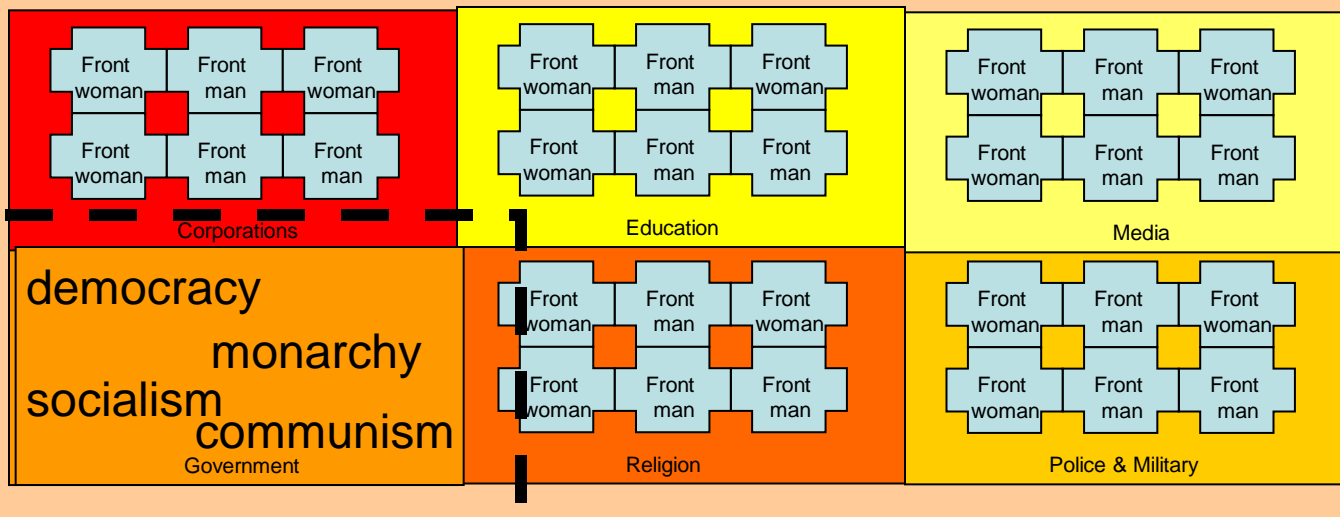

Front Groups Controlled using:

- Propaganda
- Disinformation
- Cultural programming ( leveraging cultural mythology )
- Bribes ( jobs )
- Power & Prestige ( titles, positions, etc. )
- Fear
- Threats against person
- Threats against family ( add more from overt/covert model )
- Peer pressure

General Population Controlled using:

- Propaganda
- Disinformation
- Cultural programming ( leveraging cultural mythology )
- Bribes ( jobs )
- Power & Prestige ( titles, positions, etc. )
- Fear
- Threats against person
- Threats against family ( add more from overt/covert model )
- Peer pressure

General Population

Which economic system doesn't matter. It doesn't change the model at all.

Oligarchs

Collection of control institutions form the matrix of social control systems

MATRIX of Social Control

Social Control Systems

command  
market(capitalism)  
traditional

Corporations

Front woman Front man Front woman  
Front woman Front man Front man

Education

Front woman Front man Front woman  
Front woman Front man Front man

Media

Front woman Front man Front woman  
Front woman Front man Front man

Government

Front woman Front man Front woman  
Front woman Front man Front man

Religion

Front woman Front man Front woman  
Front woman Front man Front man

Police & Military

General Population

Front Groups Controlled using:

- Propaganda
- Disinformation
- Cultural programming ( leveraging cultural mythology )
- Bribes ( jobs )
- Power & Prestige ( titles, positions, etc. )
- Fear
- Threats against person
- Threats against family ( add more from overt/covert model )
- Peer pressure

General Population Controlled using:

- Propaganda
- Disinformation
- Cultural programming ( leveraging cultural mythology )
- Bribes ( jobs )
- Power & Prestige ( titles, positions, etc. )
- Fear
- Threats against person
- Threats against family ( add more from overt/covert model )
- Peer pressure

# Oligarchs



## How does the system of control work?

“Permit me to issue and control the money of a nation and I care not who makes it’s laws.”  
 Mayer Anselm Rothschild, Founder of the famous House of Rothschild  
 2005 - There are now only 5 nations in the world left without a Rothschild controlled central bank: Iran; North Korea; Sudan; Cuba; and Libya.

The greatest trick the aristocrats ever played was to make the world think that the oligarchies no longer exist.

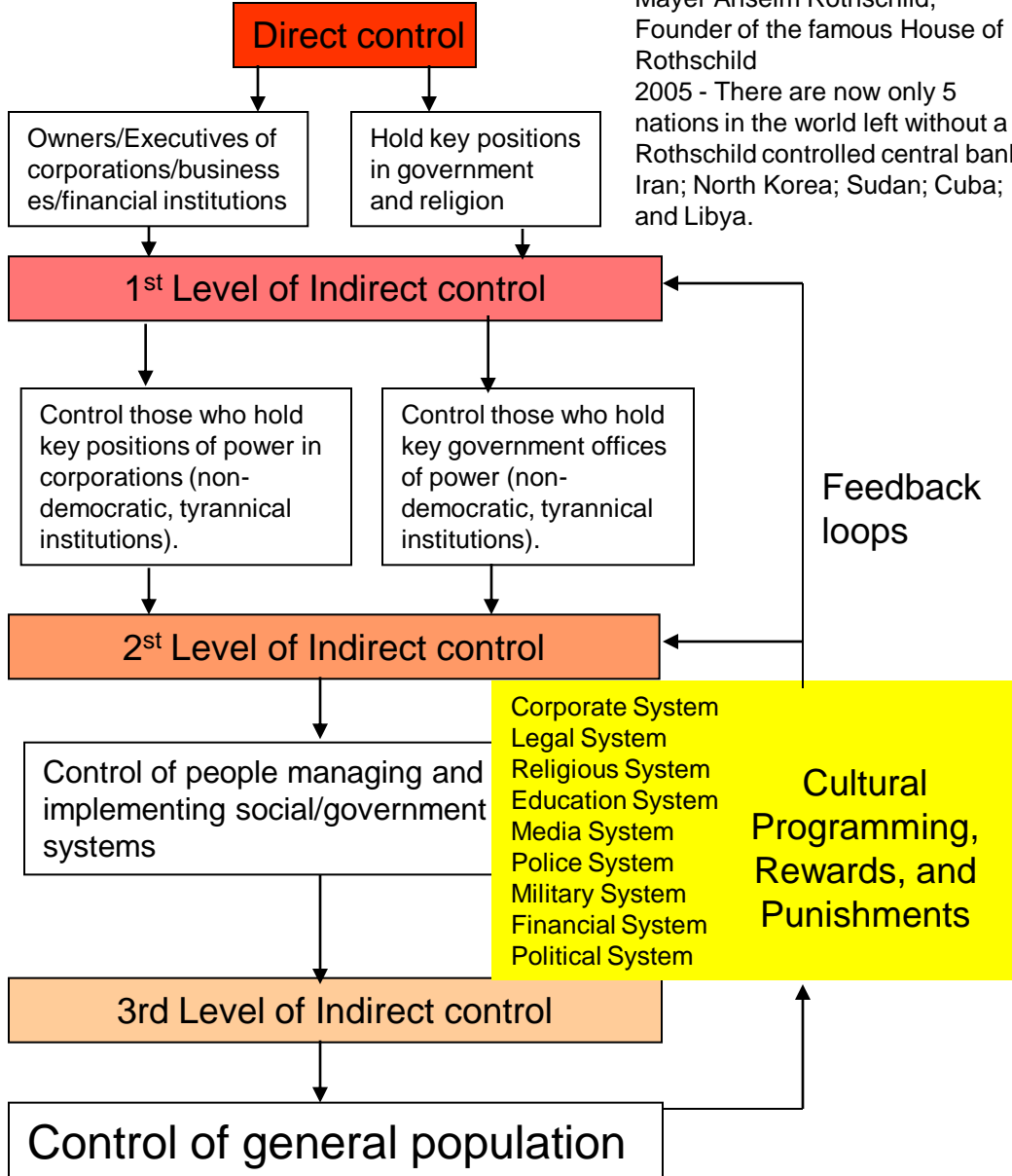

## Methods of Control

These methods are used to control individuals who are in positions where they can carry out the directives of the oligarchs. But the same methods are used against the entire population through the social institutions: Education, church, media, police and military, political process.

### Cultural Programming – A form of mind control

This is accomplished and maintained through social institutions e.g. education, media. This creates “The Believers.” Need minimum of 25% in this category to be fully indoctrinated in the system in order to maintain control of the entire system.

This is the best and most effective method of control. No rewards or punishments needed. **If you can control what a man thinks you don't have to worry about his actions.**

### Rewards for obedience

- Power and prestige
- Economic benefits:
  - Money
  - Goods
  - Services

Social “acceptance,” emotional and physical safety

### Punishments for disobedience

Threats and intimidation

- Non-physical:
  - Economic threats:
    - Professional
    - Financial
  - Threats against individual
  - Threats against family

- Physical Threats:
  - Violence against person including death
  - Violence against family including death
  - Imprisonment of person by manipulation of legal system
  - Imprisonment of family by manipulation of legal system

Social condemnation, fear, results of being outcast.

**Cultural Programming, Rewards, and Punishments**

- Corporate System
- Legal System
- Religious System
- Education System
- Media System
- Police System
- Military System
- Financial System
- Political System



# Overt or stated architecture vs covert or real architecture

## This is the real architecture of the united states

